

Keysight Technologies

EXG X-Series Signal Generators

N5171B Analog & N5172B Vector

9 kHz to 1, 3, or 6 GHz

Data Sheet



Table of Contents

Definitions and conditions.....	2
Frequency specifications.....	3
Amplitude specifications.....	5
Spectral purity specifications.....	10
Analog modulation specifications.....	12
Vector modulation specifications - N5172B only.....	17
General specifications.....	28
Inputs and outputs.....	29
Related literature.....	31

Optimized for manufacturing

On the path to faster throughput and greater uptime, the cost-effective Keysight Technologies, Inc. EXG X-Series signal generators are optimized for manufacturing test. With analog and vector models, the EXG provides the signals you'll need for basic parametric testing of components and functional verification of receivers. Get "just enough" test at the right price with the EXG.

Definitions and Conditions

Specifications represent warranted performance of a calibrated instrument that has been stored for a minimum of 2 hours within the operating temperature range of 0 to 55 °C, unless otherwise stated, and after a 45 minute warm-up period. The specifications include measurement uncertainty. Data represented in this document are specifications unless otherwise noted.

Typical (typ) describes additional product performance information that is not covered by the product warranty. It is performance beyond specifications that 80 percent of the units exhibit with a 90 percent confidence level at room temperature (approximately 25 °C). Typical performance does not include measurement uncertainty.

Nominal (nom) values indicate the expect mean or average performance, or an attribute whose performance is by design, such as the 50 ohm connector. This data is not warranted and is measured at room temperature (approximately 25 °C).

Measured (meas) describes an attribute measured during the design phase for purposes of communicating expected performance, such as amplitude drift vs. time. This data is not warranted and is measured at room temperature (approximately 25 °C).

Frequency Specifications

Frequency range			
Frequency range	Option 501 (N5171B only)	9 kHz to 1 GHz	
	Option 503	9 kHz (5 MHz IQ mode) to 3 GHz	
	Option 506	9 kHz (5 MHz IQ mode) to 6 GHz	
Resolution	0.001 Hz		
Phase offset	Adjustable in nominal 0.1 ° increments		
Frequency bands ¹			
	Band	Frequency range	N
	1	9 kHz to < 5 MHz	Digital synthesis
	1	5 to < 250 MHz	1
	2	250 to < 375 MHz	0.25
	3	375 to < 750 MHz	0.5
	4	750 to < 1500 MHz	1
	5	1500 to < 3000.001 MHz	2
	6	3000.001 to 6000 MHz	4
Frequency switching speed ^{2,3}			
	Standard	Option UNZ ⁴	Option UNZ, typical
CW mode			
SCPI mode	≤ 5 ms, typical	≤ 1.15 ms	≤ 950 μs
List/step sweep mode	≤ 5 ms, typical	≤ 900 μs	≤ 800 μs
Digital modulation on (N5172B only)			
SCPI mode	≤ 5 ms, typical	≤ 1.15 ms	≤ 1.05 ms
List/step sweep mode	≤ 5 ms, typical	≤ 900 μs	≤ 800 μs

1. N is a factor used to help define certain specifications within the document.
2. Time from receipt of SCPI command or trigger signal to within 0.1 ppm of final frequency or within 100 Hz, whichever is greater, and amplitude settled to within 0.2 dB from 20 to 30 °C. When switching into or out of band 6 amplitude settling time is within 0.3 dB. Implies simultaneous frequency and amplitude switching.
3. With internal channel corrections on, the frequency switching speed is < 1.3 ms, measured for list mode and SCPI mode cached frequency points. For the initial frequency point in SCPI mode the time is < 3.3 ms, measured. The instrument will automatically cache the most recently used 1024 frequencies. There is no speed degradation for amplitude-only changes.
4. Specifications apply when status register updates are off. For export control purposes CW switching speed to within 0.05% of final frequency is 190 μs (measured).

Frequency reference	
Accuracy	± (time since last adjustment x aging rate) ± temperature effects ± line voltage effects ± calibration accuracy
Internal time base reference oscillator aging rate ¹	≤ ± 5 ppm/10 yrs, < ± 1 ppm/yr
Initial achievable calibration accuracy	± 4 x 10 ⁻⁸ or ± 40 ppb
Adjustment resolution	< 1 x 10 ⁻¹⁰
Temperature effects	± 1 ppm (0 to 55 °C), nominal
Line voltage effects	± 0.1 ppm, nominal; 5% to -10%, nominal
Reference output	
Frequency	10 MHz
Amplitude	≥ +4 dBm, nominal into 50 Ω load
External reference input	
Input frequency, standard	10 MHz
Input frequency, Option 1ER	1 to 50 MHz (in multiples of 0.1 Hz)
Stability	Follows the stability of external reference input signal
Lock range	± 1 ppm
Amplitude	> -3.0 to 20 dBm, nominal
Impedance	50 Ω, nominal
Waveform	Sine or square
Sweep modes (frequency and amplitude)	
Operating modes	Step sweep (equally spaced frequency and amplitude or logarithmically spaced frequency steps) List sweep (arbitrary list of frequency and amplitude steps) Simultaneously sweep waveforms with N5172B; see Baseband Generator section for more detail
Sweep range	Within instrument frequency range
Dwell time	100 μs to 100 s
Number of points	2 to 65535 (step sweep) 1 to 3201 (list sweep)
Step change	Linear or logarithmic
Triggering	Free run, trigger key, external, timer, bus (GPIB, LAN, USB)

1. Not verified by Keysight N7800A TME Calibration and Adjustments Software. Daily aging rate may be verified as a supplementary chargeable service, on request.

Amplitude Specifications

Output parameters		
Settable range	+30 to -144 dBm	
Resolution	0.01 dB	
Step attenuator	0 to 130 dB in 5 dB steps electronic type	
Connector	Type N 50 Ω, nominal	
Max output power ¹ () = typical		
Frequency	Standard	Option 1EA
9 kHz to 10 MHz	+13 dBm	+17 dBm (+18 dBm)
> 10 MHz to 3 GHz	+18 dBm	+21 dBm (+26 dBm)
> 3 to 6 GHz	+16 dBm	+18 dBm (+19 dBm)

1. Quoted specifications between 20 °C and 30 °C. Maximum output power typically decreases by 0.01 dB/°C for temperatures outside this range.

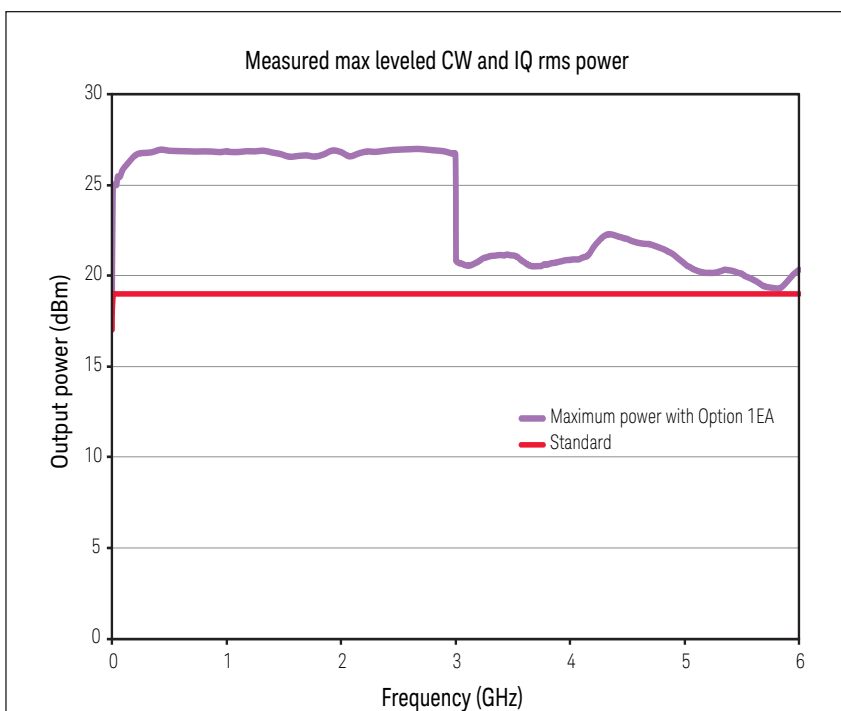

Absolute level accuracy in CW mode ¹ (ALC on) ()= typical			
Range	Max power to -60 dBm	< -60 to -110 dBm	< -110 to -127 dBm
9 to 100 kHz	(± 0.6)	(± 0.9)	
100 kHz to 5 MHz	± 0.8 dB (± 0.3)	± 0.9 dB (± 0.3)	
> 5 MHz to 3 GHz	± 0.6 dB (± 0.3)	± 0.8 dB (± 0.3)	(± 0.5)
> 3 to 6 GHz	± 0.6 dB (± 0.3)	± 1.1 dB (± 0.3)	(± 0.6)
Absolute level accuracy in CW mode (ALC off, power search run, relative to ALC on)			
9 kHz to 6 GHz	± 0.15 dB, typical		
Absolute level accuracy in digital I/Q mode (N5172B only)			
(ALC on, relative to CW, W-CDMA 1 DPCH configuration < +10 dBm)			
5 MHz to 6 GHz	± 0.25 dB, (0.05 dB)		

1. Quoted specifications between 20 °C and 30 °C. For temperatures outside this range, absolute level accuracy degrades by 0.01 dB/°C. Output power may drift up to 0.10 dB < 3 GHz and 0.15 dB > 3 GHz per g/kg change in absolute humidity (nom).

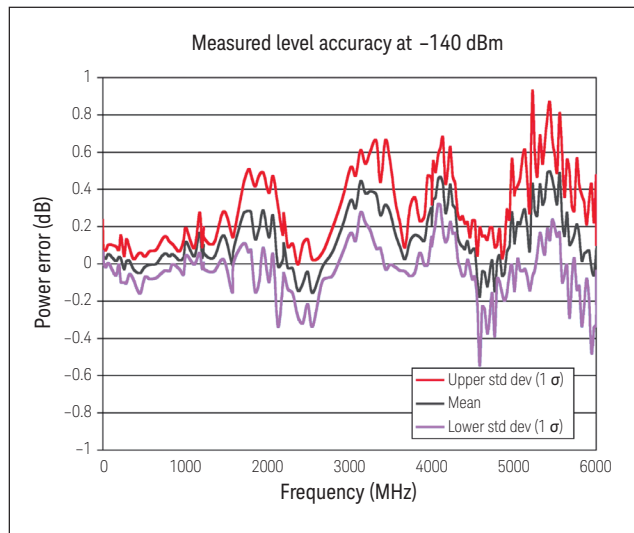
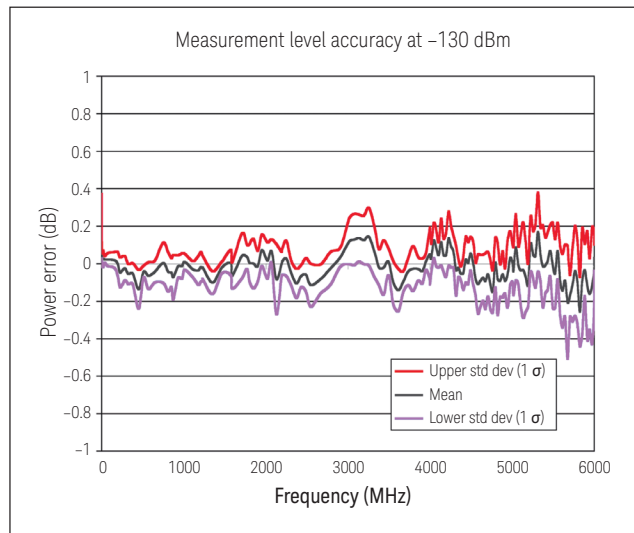
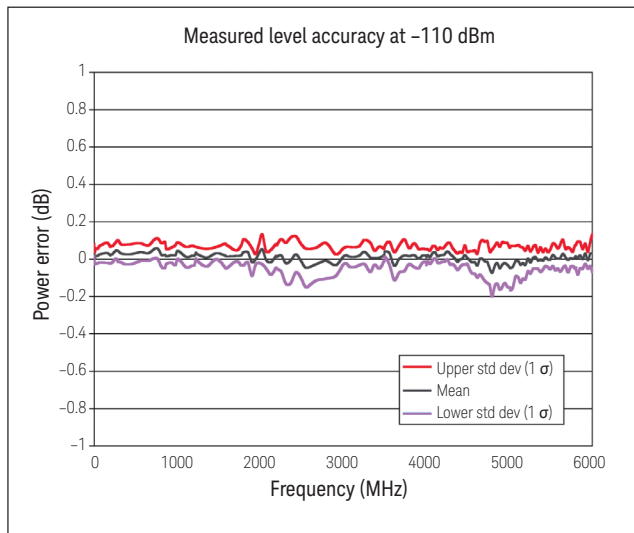

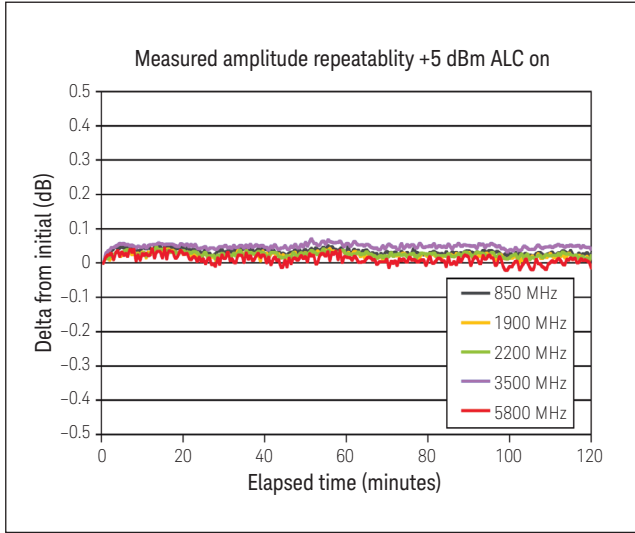

Repeatability measures the ability of the instrument to return to a given power setting after a random excursion to any other frequency and power setting. It should not be confused with absolute level accuracy.

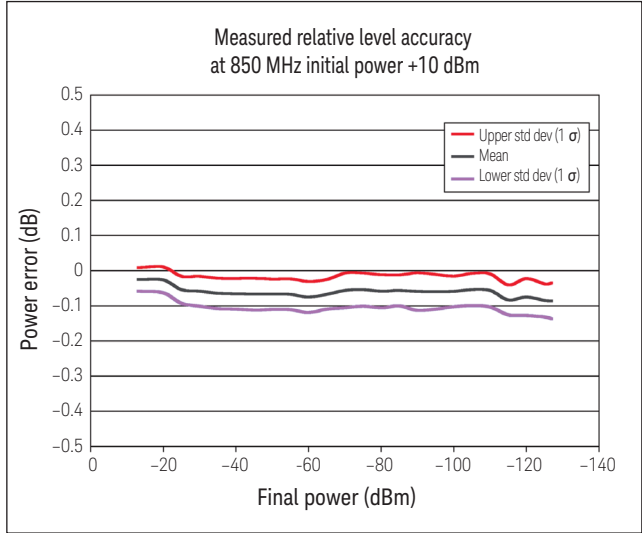

Relative level accuracy measures the accuracy of a step change from any power level to any other power level. This is useful for large changes (such as 5 dB steps).

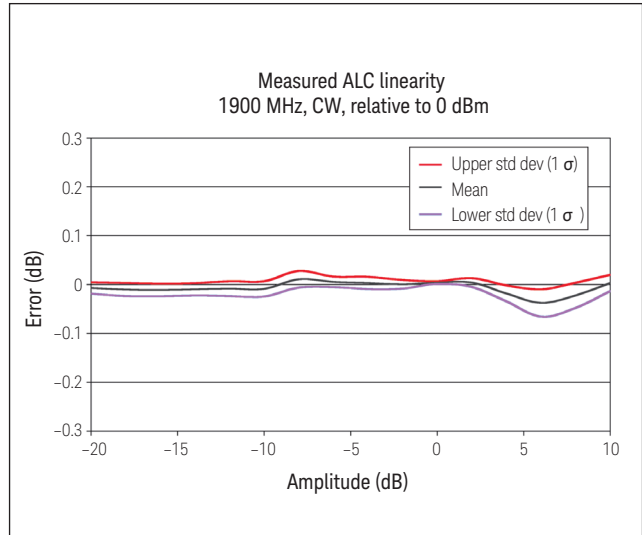
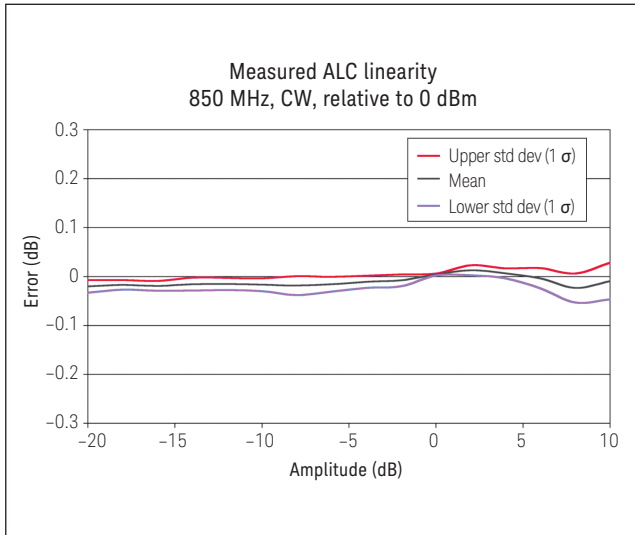

SWR (measured CW mode) ¹			
Frequency	Attenuator state		
	Bypass	0 to 10 dB	15 dB or more
≤ 1.0 GHz	< 1.3:1	< 1.35:1	< 1.2:1
> 1.0 to 2 GHz	< 1.55:1	< 1:5:1	< 1.3:1
> 2 to 3 GHz	< 1.8:1	< 1.5:1	< 1.45:1
> 3 to 4 GHz	< 1.5:1	< 1.6:1	< 1.7:1
> 4 to 6 GHz	< 1.9:1	< 1.6:1	< 1.6:1

1. SWR < 1.60:1 below 30 kHz.

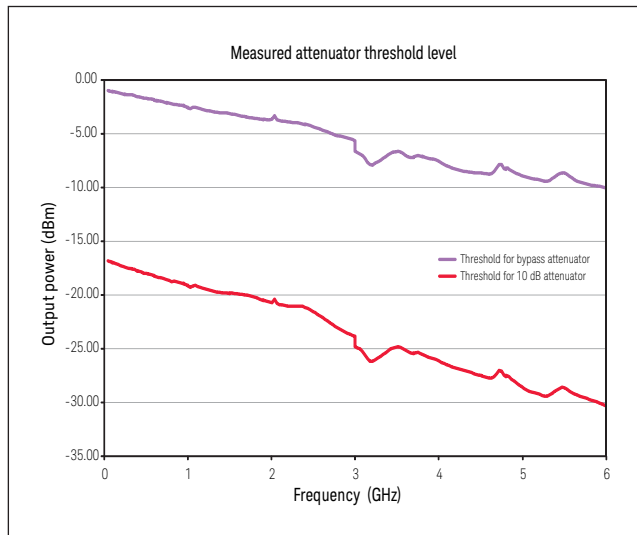
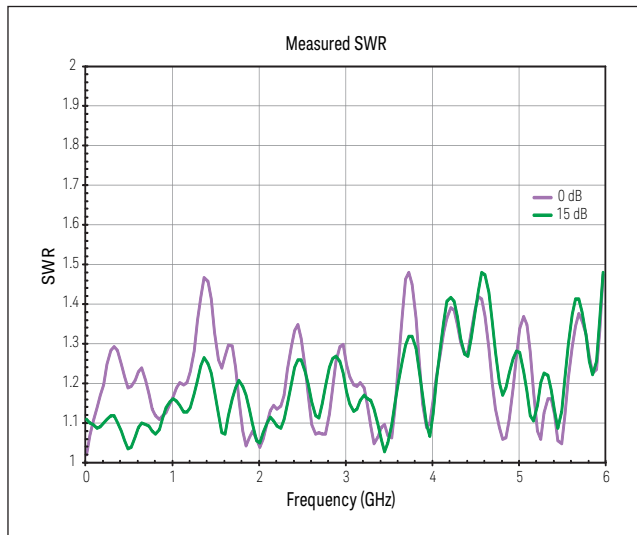

Maximum reverse power, nominal			
< 1 GHz	50 W		
> 1 to 2 GHz	25 W		
> 2 to 6 GHz	20 W		
Max DC voltage	50 VDC		
Trip level	2 W		
Amplitude switching speed¹	Standard	Option UNZ	Option UNZ, typical
CW mode			
SCPI mode	≤ 5 ms, typical	≤ 750 μs	≤ 650 μs
Power search SCPI mode	< 12 ms, measured		
List/step sweep mode	≤ 5 ms, typical	≤ 500 μs	≤ 300 μs
Digital modulation on (N5172B only)			
SCPI mode	≤ 5 ms, typical	≤ 1.15 ms	≤ 950 μs
Power search SCPI mode	< 12 ms, measured		
List/step sweep mode	≤ 5 ms, typical	≤ 900 μs	≤ 400 μs
Alternate power level control (N5172B only)			
Switching time (via waveform markers)	20 μs within ± 1 dB, measured		
Functional power range	-15 dBm to -144 dBm, measured		
User flatness correction			
Number of points	3201		
Number of tables	Dependent on available free memory in instrument; 10,000 maximum		
Entry modes	USB/LAN direct power meter control, LAN to GPIB and USB to GPIB, remote bus and manual USB/GPIB power meter control		
Sweep modes			
	See Frequency Specifications section for more detail		

1. Time from receipt of SCPI command or trigger signal to amplitude settled within 0.2 dB. Switching speed specifications apply when status register updates are off.

Spectral Purity Specifications

Absolute SSB phase noise (dBc/Hz, CW at 20 kHz offset, typical)	
5 MHz to < 250 MHz	-119
250 MHz	-133
500 MHz	-128
1 GHz	-122
2 GHz	-115
3 GHz	-110
4 GHz	-109
6 GHz	-103

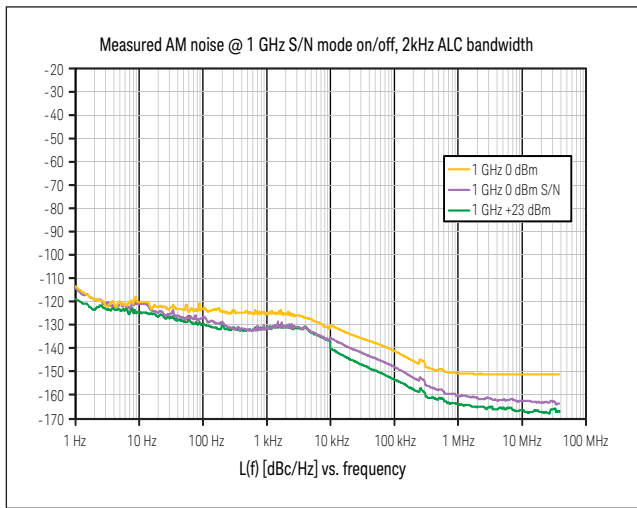
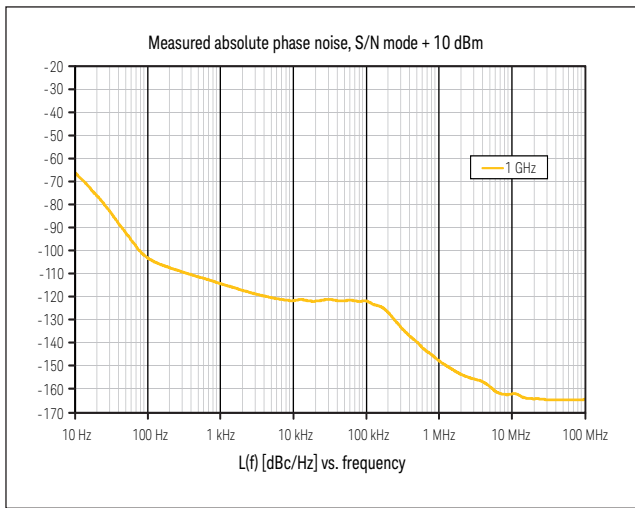
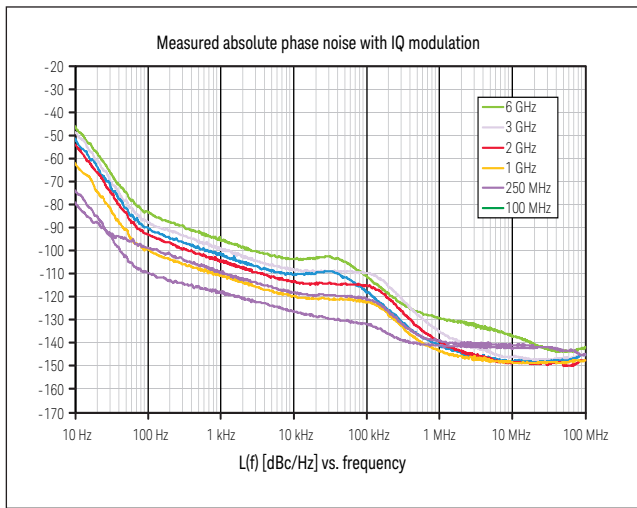
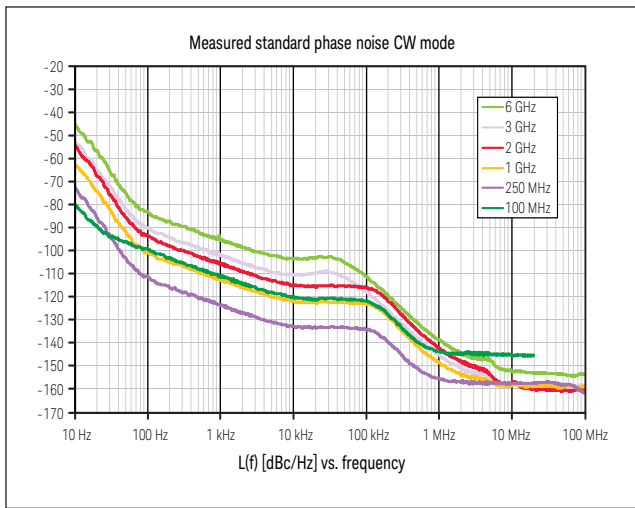

Residual FM (CW mode, 300 Hz to 3 kHz BW, CCITT, rms)				
5 MHz to 6 GHz	< $N \times 2$ Hz (measured) (see N value in frequency band table)			
Residual AM (CW mode, 0.3 to 3 kHz BW, rms, +5 dBm)				
100 kHz to 3 GHz	< 0.01% (measured)			
Harmonics (CW mode)				
Range	Standard < +4 dBm	Option 1EA < +12 dBm		
9 kHz to 3 GHz	< -35 dBc	< -30 dBc		
> 3 to 4 GHz	< -35 dBc, typical	< -35 dBc, typical		
> 4 to 6 GHz	< -53 dBc, typical	< -40 dBc, typical		
Nonharmonics (CW mode)				
Range	> 10 KHz offset			
	Standard (dBc)			
9 kHz to < 5 MHz	-65, nominal			
5 to < 250 MHz	-75			
250 to < 750 MHz	-75			
750 MHz to < 1.5 GHz	-72			
1.5 to < 3.0 GHz	-66			
3 to 6 GHz	-60			
Subharmonics (CW mode)				
9 kHz to 1.5 GHz	None			
> 1.5 to 3 GHz	-77 dBc			
> 3 to 6 GHz	-74 dBc			
Jitter ¹				
Carrier frequency	SONET/SDH data rate	rms jitter BW	μ UI rms, measured	Seconds, typical
155 MHz	155 MB/s	100 Hz to 1.5 MHz	140	0.9 ps
622 MHz	622 MB/s	1 KHz to 5 MHz	67	0.11 ps
2.488 GHz	2488 MB/s	5 kHz to 20 MHz	271	0.11 ps
Phase coherence (Option 012)				
LO input frequency range	250 MHz to 6 GHz, nominal			
LO input power range	0 to +12 dBm, nominal			
LO output frequency range	250 MHz to 6 GHz, nominal			
LO output power range	0 to +12 dBm, nominal			

1. Calculated from phase noise performance in CW mode at +10 dBm. For other frequencies, data rates, or bandwidths, please consult your sales representative.

Analog Modulation Specifications

Frequency bands		
Band #	Frequency range	N
1	9 kHz to < 5 MHz	1 (digital synthesis)
1	5 to < 250 MHz	1
2	250 to < 375 MHz	0.25
3	375 to < 750 MHz	0.5
4	750 to < 1500 MHz	1
5	1500 to < 3000.001 MHz	2
6	3000.001 to 6000 MHz	4
Frequency modulation (Option UNT) (See N value above)		
Max deviation	N × 10 MHz, nominal ³	
Resolution	1 Hz, nominal	
Deviation accuracy	< ± 2% + 20 Hz (1 kHz rate, deviation is N × 50 kHz)	
Modulation frequency response @ 100 kHz deviation	1 dB bandwidth	DC/5 Hz to 3 MHz, nominal
	3 dB bandwidth	DC/1 Hz to 7 MHz, nominal
Carrier frequency accuracy	< ± 0.2% of set deviation + (N × 1 Hz) ¹	
Relative to CW in DCFM	< ± 0.06% of set deviation + (N × 1 Hz), typical ²	
Total harmonic distortion	< 0.4% [1 kHz rate, deviation is N × 50 kHz]	
FM using external inputs 1 or 2	Sensitivity	+1 V peak for indicated deviation, nominal
	Input impedance	50 Ω/600 Ω/1 M Ω, nominal
	Paths	FM path 1 and FM path 2 are summed internally for composite modulation
Phase modulation (Option UNT) (See N value above)		
Maximum deviation	Normal bandwidth	N × 5 radians, nominal
	High-bandwidth mode	N × 0.5 radians, nominal
Frequency response	Normal bandwidth (3 dB)	DC to 1 MHz, nominal
	High-bandwidth mode (3 dB)	DC to 4 MHz, nominal
Resolution	0.1% of deviation	
Deviation accuracy	< + 0.5% + 0.01 rad, typical [1 kHz rate, normal bandwidth mode]	
Total harmonic distortion	< 0.2% (typ) [1 kHz rate, N × 1 radian deviation normal bandwidth mode]	
ΦM using external inputs 1 or 2	Sensitivity	+1 V peak for indicated deviation, nominal
	Input impedance	50 Ω or 600 Ω or 1 M Ω, nominal
	Paths	ΦM path 1 and ΦM path 2 are summed internally for composite modulation

1. Specification valid for temperature changes of less than ± 5 °C since last DCFM calibration.

2. Typical performance immediately after a DCFM calibration.

3. Digital synthesis band FM deviation is 5 MHz.

Amplitude modulation (Option UNT)¹						
AM depth type	Linear or exponential					
Maximum depth	100%					
Depth resolution	0.1% of depth (nom)					
AM depth error @1 KHz rate and < 80% depth	f < 5 MHz	< 1.5% of setting + 1% (typ 0.5% of setting + 1%)				
	5 MHz ≤ f ≤ 2 GHz	< 3% of setting + 1 %				
	2 < f < 3 GHz	< 5% of setting + 1% (typical 3% of setting + 1%)				
Total harmonic distortion @ 1 KHz rate	F < 5 MHz	30% depth	< 0.25%, typical			
		80% depth	< 0.5%, typical			
	5 MHz ≤ f < 2 GHz (2 to 3 GHz is typical)	30% depth	< 2%			
		80% depth	< 2%			
Frequency response	30% depth, 3 dB BW	DC/10 Hz to 50 KHz				
Frequency response wideband AM (N5172B only)	Rates ALC off/on:	DC/800 Hz to 80 MHz, nominal				
AM inputs using external inputs 1 or 2	Sensitivity	+1 V peak for indicated depth (Over-range can be 200% or 2.2 V peak)				
	Input impedance	50 Ω or 600 Ω or 1M Ω, Damage level: ± 5 V max				
	Paths	AM path 1 and AM path 2 are summed internally for composite modulation				
Wideband AM inputs (N5172B only)	Sensitivity	0.25 V = 100% (I input + 0.5 V offset)				
	Input impedance	50 Ω, nominal (I input)				
Simultaneous and composite modulation²						
Simultaneous modulation	All modulation types (I/Q, FM, AM, ΦM, and pulse modulation) may be simultaneously enabled except: FM and phase modulation cannot be combined and two modulation types cannot be simultaneously generated using the same modulation source; for example, the baseband I/Q generator, AM, and FM can run concurrently and all will modulate the output RF (this is useful for simulating signal impairments)					
Composite modulation	AM, FM, and ΦM each consist of two modulation paths which are summed internally for composite modulation; modulation can be any combination of internal or external sources					
	AM	FM	Phase	Pulse	Internal I/Q ²	External I/Q ²
AM	+	+	+	+	+	+
FM	+	+	-	+	+	+
Phase	+	-	+	+	+	+
Pulse	+	+	+	-	+	+
Internal I/Q ²	+	+	+	+	*	+
External I/Q ²	+	+	+	+	+	-
+ = compatible, - = incompatible, * = Internal + External						

1. AM specifications apply 6 dB below maximum specified power from 20 to 30 °C.

2. I/Q modulation available on N5172B.

External modulation inputs	
(Option UNT required for FM, AM, and phase modulation inputs; Option UNW required for pulse modulation inputs)	
EXT1	AM, FM, PM
EXT2	AM, FM, PM
PULSE	Pulse (50 Ω only)
I	Wideband AM (50 Ω only, N5172B only)
Input impedance	50 Ω, 1 MΩ, 600 Ω, DC and AC coupled
Standard internal analog modulation source	
(Single sine wave generator for use with AM, FM, phase modulation requires Option UNT or 303)	
Waveform	Sine, square, triangle, positive ramp, negative ramp
Rate range	0.1 Hz to 2 MHz (tunable to 3 MHz)
Resolution	0.1 Hz
Frequency accuracy	Same as RF reference source, nominal
LF audio output	0 to 5 V peak into 50 Ω, -5 V to 5 V offset, nominal
Multifunction generator (Option 303)	
The multifunction generator option (Option 303) consists of seven waveform generators that can be set independently with up to five simultaneously using the composite modulation features in AM, FM/PM, and LF out	
Waveform	
Function generator 1	Sine, triangle, square, positive ramp, negative ramp, pulse
Function generator 2	Sine, triangle, square, positive ramp, negative ramp, pulse
Dual function generator	Sine, triangle, square, positive ramp, negative ramp, phase offset, and amplitude ratio for Tone 2 relative to Tone 1
Swept function generator	Sine, triangle, square, positive ramp, negative ramp Trigger: free run, trigger key, bus, external, internal, timer trigger
Noise generator 1	Uniform, Gaussian
Noise generator 2	Uniform, Gaussian
DC	Only for LF output -5 V to +5 V, nominal
Frequency parameters	
Sine wave	0.1 Hz to 10 MHz, nominal
Triangle, square, ramp, pulse	0.1 Hz to 1 MHz, nominal
Noise bandwidth	10 MHz, nominal
Resolution	0.1 Hz
Frequency accuracy	Same as RF reference source, nominal
Narrow pulse modulation (Option UNW)¹ () = typical	
On/off ratio	(> 80 dB)
Rise/fall times (Tr, Tf)	< 10 ns; (7 ns)
Minimum pulse width ALC on/off	≥ 2 μs/≥ 20 ns
Repetition frequency ALC on/off	10 Hz to 500 kHz/DC to 10 MHz
Level accuracy (relative to CW) ALC on/off ²	< ± 1.0 dB (± 0.5 dB)/(< ± 0.5) dB
Width compression (RF width relative to video out)	(< 5 ns)

1. Pulse specifications apply to frequencies > 100 MHz and power set to > -3 dBm. Operable down to 9 kHz.

2. With power search on.

Video feed-through ¹ ≤ 3 GHz/ > 3 GHz	(< 50 mV/< 5 mV)
External video delay (ext input to video)	30 ns, nominal
RF delay (video to RF output)	20 ns, nominal
Pulse overshoot	(< 15%)
Input level	+1 V _{peak} = RF on into 50 Ω , nominal

T_d video delay (variable)
 T_w video pulse width (variable)
 T_p pulse period (variable)
 T_m RF delay
 T_{rf} RF pulse width
 T_f RF pulse fall time
 T_r RF pulse rise time
 V_{or} pulse overshoot
 V_f Video feedthrough

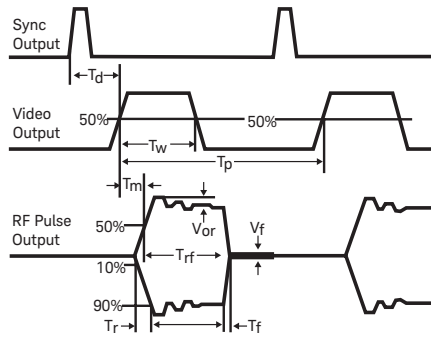

Internal pulse generator (included with Option UNW)

Modes	Free-run, square, triggered, adjustable doublet, trigger doublet, gated, and external pulse	
Square wave rate	0.1 Hz to 10 MHz, 0.1 Hz resolution, nominal	
Pulse period	30 ns to 42 seconds, nominal	
Pulse width	20 ns to pulse period -10 ns, nominal	
Resolution	10 ns	
Adjustable trigger delay	(-pulse period + 10 ns) to (pulse width -10 ns)	
Settable delay	Free run	-3.99 to 3.97 μ s
	Triggered	0 to 40 s
Pulse doublets	1st pulse delay	(Relative to sync out) 0 to 42 s - pulse width - 10 ns
	1st pulse width	500 ns to 42 s - delay - 10 ns
	2nd pulse delay	0 to 42 s - (Delay 1 + Width 2) - 10 ns
	2nd pulse width	20 ns to 42 s - (Delay 1 + Delay 2) - 10 ns

Pulse train generator Option 320 (requires Option UNW)

Number of pulse patterns	2047
On/off time range	20 ns to 42 sec

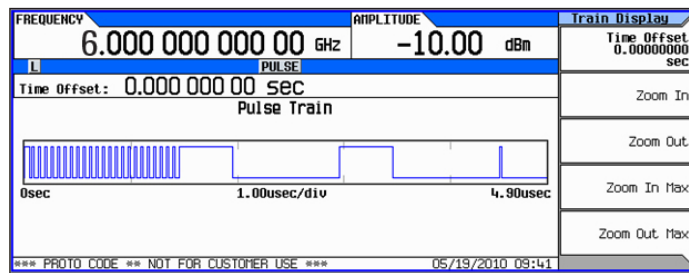

1. Video feed through applies to power levels < +10 dBm.

Avionics (Option 302)		
VOR		
Bearing accuracy		± 0.1 degrees
Frequency accuracy		Same as RF reference source, nominal
AM accuracy	30% depth	± 5% of setting
AM distortion		2%
FM accuracy	480 Hz deviation	± 1.7 Hz
ILS: localizer and glide slope		
AM accuracy	40% depth	± 5% of setting
AM distortion		2%
Difference in depth of modulation (DDM) resolution	Localizer	0.0002
	Glide slope	0.0004
Difference in depth of modulation (DDM) accuracy	Localizer	± 0.0004 ± 5% of DDM ¹
	Glide slope	± 0.0008 ± 5% of DDM ¹
Marker beacon		
Marker tone AM accuracy	95% depth	± 5% of setting + 1%
Marker tone AM distortion	95% depth	5%

1. DDM must not be equal to 0.

Vector Modulation Specifications

N5172B only

I/Q modulator external inputs ¹		
Bandwidth	Baseband (I or Q)	Up to 100 MHz baseband, nominal
	RF (I+Q)	Up to 200 MHz RF, nominal
I or Q offset	± 100 mV (200 uV resolution)	
I/Q gain balance	± 4 dB (0.001 dB resolution)	
I/Q attenuation	0 to 50 dB (0.01 dB resolution)	
Quadrature angle adjustment	± 200 units	
Full scale input drive (I+Q)	0.5 V into 50 Ω, nominal	
Internal I/Q baseband generator adjustments ^{1,2} (Options 653 and 655)		
I/Q offset	± 20%	(0.025% dB resolution)
I/Q gain	± 1 dB	(0.001 dB resolution)
Quadrature angle adjustment	± 10 °	(0.01 degrees resolution)
I/Q phase	± 360.00 °	(0.01 degrees resolution)
I/Q skew	± 500 ns	(1 picosecond resolution)
I/Q delay	± 250 ns	(1 picosecond resolution)
External I/Q outputs ¹		
Impedance	50 Ω, nominal per output	
	100 Ω, nominal differential output	
Type	Single-ended or differential (Option 1EL)	
Maximum voltage per output	1 V peak-to-peak or 0.5 V peak; into 50 Ω (200 uV resolution)	
Bandwidth (I, Q)	Baseband (I or Q)	60 MHz, nominal (Option 653 and 655)
	RF (I+Q)	120 MHz, nominal (Option 653 and 655)
Amplitude flatness	± 0.2 dB measured with channel corrections optimized for I/Q output	
Phase flatness	± 2.5 degrees measured with channel corrections optimized for I/Q output	
Common mode I/Q offset	± 1.5 V into 50 Ω (200 uV resolution)	
Differential mode I or Q offset	± 50 mV into 50 Ω (200 uV resolution)	

1. I/Q adjustments represent user interface nominal parameter ranges and not specifications.
2. Internal I/Q adjustments apply to RF out and I/Q outputs simultaneously.

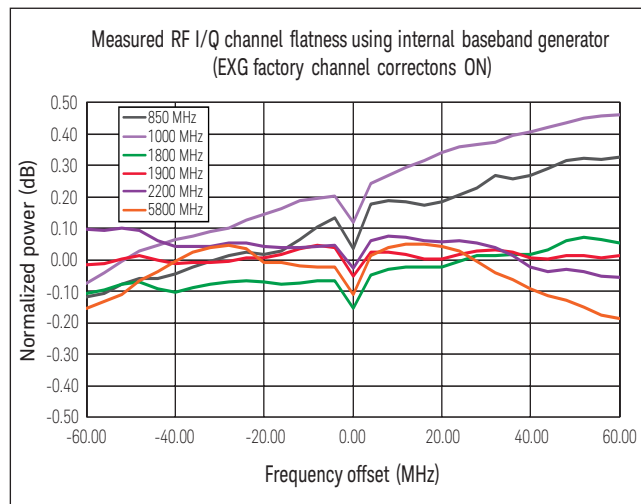
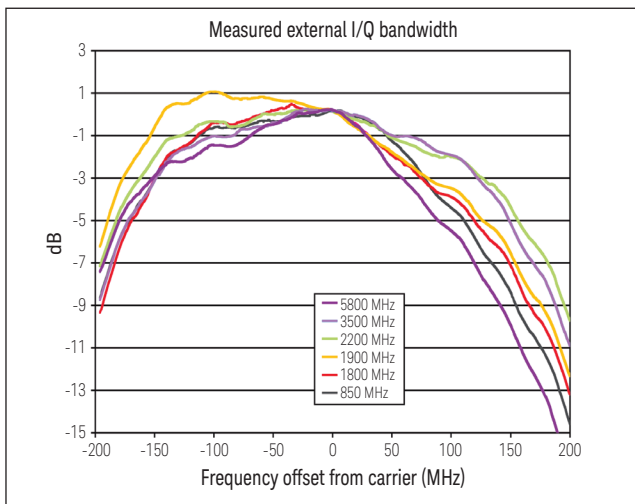

Internal real-time complex digital I/Q filters (included with Option 653)		
Factory channel correction (256 taps)		
Corrects the linear phase and amplitude response of the baseband I/Q and RF outputs of the signal generator using factory calibration arrays (default mode is off).		
RF amplitude flatness (120 MHz)	± 0.2 dB measured	
RF phase flatness (120 MHz)	± 2 degrees measured	
User channel correction (256 taps)		
Automated routine uses USB power sensor to correct for linear phase and amplitude response of DUT (equalizer). See User Guide for more details.		
Max RF amplitude flatness correction	± 15 dB	
Max RF phase flatness correction	± 20 degrees	
Equalization filter (256 taps)		
User can download and apply inverse or custom phase and amplitude response coefficients from tools such as MATLAB, 89600 VSA, or SystemVue to correct for linear errors of DUT/system. See User Guide for more details.		
Baseband generator (Options 653 and 655)		
Channels	2 [I and Q]	
Resolution	16 bits [1/65,536]	
Sample rate	Option 653	100 Sa/s to 75 MSa/s
	Option 653 and 655	100 Sa/s to 150 MSa/s
RF (I+Q) bandwidth	Option 653	60 MHz, nominal
	Option 653 and 655	120 MHz, nominal
Interpolated DAC rate	800 MHz (waveforms only need OSR = 1.25)	
Frequency offset range	± 60 MHz	
Digital sweep modes	In list sweep mode each point in the list can have independent waveforms (N5172B) along with user definable frequencies and amplitudes; see the Amplitude and Frequency Specifications sections for more detail.	
Waveform switching speed ¹	SCPI mode	≤ 5 ms, measured (standard)
		≤ 1.2 ms, measured (Option UNZ)
	List/step sweep mode	≤ 5 ms, measured (standard)
		≤ 900 us, measured (Option UNZ)
Waveform transfer rates (measured, no markers, unencrypted)	FTP LAN to internal SSD	10.7 MB/sec or 2.67 Msa/sec
	Internal SSD to FTP LAN	7.7 MB/sec 1.92 Msa/sec
	FTP LAN to BBG	8.2 MB/sec or 2.05 Msa/sec
	FTP LAN to BBG encrypted	4 MB/sec or 1 Msa/sec
	USB to BBG	19 MB/sec or 4.75 Msa/sec
	BBG to USB	1.2 MB/sec or 300 Ksa/sec
	Internal SSD to BBG	48 MB/sec or 12 Msa/sec
	BBG to internal SSD	1.2 MB/sec or 300 Ksa/sec
	SD card to BBG (Option 006)	
BBG to SD card (Option 006)	845 KB/sec or 211 Ksa/sec	

1. SCPI mode switching speed applies when waveforms are pre-loaded in list sweep and sample rate ≥ 10 MSa/s.

Arbitrary waveform memory	Maximum playback capacity	32 Msa (standard)	
		256 Msa (Option 021)	
		512 Msa (Option 022)	
Maximum storage capacity including markers	3 GBytes/800 Msa (standard)		
	30 GBytes/7.5 Gsa (Option 009)		
	8 GBytes / 2 Gsa (Option 006)		
Waveform segments	Segment length	60 samples to 32 Msa (standard)	
		60 samples to 256 Msa (Option 021)	
		60 samples to 512 Msa (Option 022)	
	Minimum memory allocation per segment	256 samples	
Maximum number of segments	8192		
Waveform sequences	Maximum number of sequences	> 2000 depending on non-volatile memory usage	
	Maximum number of segments/sequence	32,000 (standard)	
		4 million (Option 021 or 022)	
Maximum number of repetitions	65,535		
Triggers	Types	Continuous, single, gated, segment advance	
	Source	Trigger key, external, bus (GPIO, LAN, USB)	
	Modes	Continuous	Free run, trigger and run, reset and run
		Single	No retrigger, buffered trigger, restart on trigger
		Gated	Negative polarity or positive polarity
		Segment advance	Single or continuous
	External coarse delay time	5 ns to 40 s	
	External coarse delay resolution	5 ns	
	Trigger latency (Single trigger only)	356 ns + 1 sample clock period, nominal	
	Trigger accuracy (Single trigger only)	± 2.5 ns, nominal	
Single trigger - restart on trigger mode will initiate a FIFO clear. Therefore, the latency includes re-filling the buffer. The latency is 8 μs + (1406 x sample period) ± 1 sample clock period, nominal			
Multi-baseband generator synchronization mode (multiple sources)	Fan out	1 master and up to 15 slaves	
	Trigger repeatability	< 1 ns, nominal	
	Trigger accuracy	Same as normal mode	
	Trigger latency	Same as normal mode	
	Fine trigger delay range	See Internal I/Q Baseband section	
	Fine trigger delay resolution	See Internal I/Q Baseband section	
	I/Q phase adjustment range	See Internal I/Q Baseband section	
Markers	Markers are defined in a segment during the waveform generation process, or from the front panel; a marker can also be routed to the RF blanking, ALC hold functions, and alternate amplitude; see Users Guide for more information		
	Marker polarity	Negative, positive	
	Number of markers	4	
	RF blanking/burst on/off ratio	> 80 dB	
	Alternate amplitude control switching speed	See amplitude section	

Real-time modulation FIR filter:	Nyquist, root-Nyquist, WCDMA, EDGE, Gaussian, rectangular, APCO 25 C4FM, IS-95, User FIR (Applies real-time FIR filtering when playing waveforms with OSR=1. Helps reduce waveform size for long simulation times. Option 660 not required).	
Real-time baseband generator (Option 660)		
Real-time baseband generator required for real-time Signal Studio applications ¹	Cellular real-time applications	LTE-FDD, LTE-TDD, HSPA+/W-CDMA, GSM/EDGE, cdma2000®
	Real-time navigation	GPS, GLONASS, Galileo
	Real-time video applications	DVB-T/T2/H/S/S2/C/J.83 Annex A/C, ISDB-T/
	Note: Option 660 is not required for real-time custom modulation (Option 431)	
	Memory: Shares memory with Options 653 and 655	
	Triggering: Same as Options 653 and 655	
Markers: 3 markers available, all other features are same as Options 653 and 655		
Digital baseband inputs/outputs (Option 003/004)		
Options 003 and 004 activate the rear panel digital I/Q bus and enables connectivity to the N5102A digital signal interface module. In output mode (003), you can deliver realistic complex-modulated signals such as LTE, GPS, WLAN, custom pulses and many others directly to your digital devices and subsystems. In the input mode (004), the interface module ports your digital input to the signal generator's baseband system, providing a quick and easy way of upconverting to calibrated analog I/Q, IF, or RF frequencies. In both operating modes, the interface module adapts to your device with the logic type, data format, clock features, and signaling you require.		
Data (requires N5102A)		
Digital data format	User-selectable: 2's complement or binary offset, I/Q (I, I-bar, Q, Q-bar) or digital IF output (real, imaginary)	
Data port	Dual 16-bit data buses support parallel, parallel I/Q interleaved, parallel QI interleaved, or serial port configuration	
N5102A connectors (breakout boards)	144-pin Tyco Z-Dok+ connects to break-out boards (included with N5102A) that interface with the following connector types: 68-pin SCSI, 38-pin dual AMP Mictor, 100-pin dual Samtec, 20-pin dual 0.1 inch headers, 40-pin dual 0.1 inch headers	
Logic types	Single-ended: LVTTTL, 1.5V CMOS, 1.8V CMOS, 2.5V CMOS, 3.3V CMOS	
	Differential: LVDS	
Data output resampling	EXG baseband output is resampled to the arbitrary clock rate set by the user via real-time curve-fit calculations.	

1. See www.keysight.com/find/signalstudio for more information.

Clock (requires N5102A)	
Clock input	User selectable: internal clock, device under test clock, or external clock (via SMA or breakout board) N5102A SMA Ext Clock In connector: 50 Ω , 0 dBm nominal, 1 to 400 MHz
Clock output	User selectable: via breakout board or SMA Clock Out connector N5102A SMA Clock Out connector: 2 Vpp into load > 5 K Ω from 1 to 100 kHz, 400 mVpp into 50 Ω load from 100 kHz to 400 MHz
Sample rate (limited by EXG sample rate)	User-selectable in parallel mode up to a maximum 150 MHz, but limited by other user settings (see N5102A users guide for more details). User-selectable in serial mode, the maximum rate is 400 MHz/word size.
Bit rate (limited by EXG sample rate)	Parallel Up to 150 MHz x word size (1.6 Gbps LVDS, CMOS and LVTTTL) per parallel bus, 2 parallel buses available Serial Up to 400 MHz per serial line (400 Mbps LVDS) or 150 MHz per serial line (150 Mbps (CMOS/LVTTTL) 32 lines available
Clocks per sample	In parallel output mode, the data sample can be held for 1, 2 or 4 clock cycles
Clock to data skew	Coarse adjustment in 90° steps from 0 to 270°; fine-adjustment in increments of 100 ps up to 5 ns
Clock polarity	Clock signals may be inverted
Frequency reference input	1 to 100 MHz BNC, 50 Ω , 3 dBm \pm 6 dB,
Power supply (included on N5102A)	Output: 5 V, 4 A DC
AWGN (Option 403)	
Type	Real-time, continuously calculated, and played using DSP
Modes of operation	Standalone or digitally added to signal played by arbitrary waveform or real-time baseband generator
Bandwidth	With Option 653 1 Hz to 60 MHz With Option 653 and 655 1 Hz to 120 MHz
Crest factor	15 dB
Randomness	90 bit pseudo-random generation, repetition period 313 x 10 ⁹ years
Carrier-to-noise ratio	\pm 100 dB when added to signal
Carrier-to-noise ratio formats	C/N, Eb/No
Carrier-to-noise ratio error	Magnitude error \leq 0.2 dB at baseband I/Q outputs
Custom modulation Arb Mode (Option 431)	
Modulation	PSK BPSK, QPSK, OQPSK, π /4DQPSK, gray coded and unbalanced QPSK, 8PSK, 16PSK, D8PSK QAM 4, 16, 32, 64, 128, 256, 1024 (and 89600 VSA mappings) FSK Selectable: 2, 4, 8, 16, C4FM MSK 0 to 100° ASK 0 to 100%
Multicarrier	Number of carriers Up to 100 (limited by a max bandwidth of 120 MHz depending on symbol rate and modulation type) Frequency offset (per carrier) Up to -60 to +60 MHz Power offset (per carrier) 0 dB to -40 dB
Symbol rate	50 sps to 75 Msps
Filter types	Nyquist, root-Nyquist, Gaussian, rectangular, APCO 25 C4FM, user
Quick setup modes	APCO 25w/C4FM, APCO25 w/CQPSK, Bluetooth®, CDPD, DECT, EDGE, GSM, NADC, PDC, PHS, PWT, TETRA
Data	Random only

Custom modulation real-time mode (Option 431) (Does not require Option 660)				
Modulation	PSK	BPSK, QPSK, OQPSK, $\pi/4$ DQPSK, gray coded and unbalanced QPSK, 8PSK, 16PSK, D8PSK, IS95 QPSK, IS95 OQPSK, EDGE, HDQPSK, SOQPSK		
	QAM	4, 16, 32, 64, 128, 256, 1024 (and 89600 VSA mappings)		
		Selectable	2,4,8, 16 level symmetric, C4FM, HCPM	
	FSK	User-defined	Custom map of up to 16 deviation levels	
		Max deviation	20 MHz	
	MSK	0 to 100°		
	ASK	0 to 100%		
	DVB-S2 APSK	16APSK 2/3, 16APSK 3/4, 16APSK 4/5, 16APSK 5/6, 16APSK 8/9, 16APSK 9/10, 32APSK 3/4, 32APSK 4/5, 32APSK 5/6, 32APSK 8/9, 32APSK 9/10		
Custom I/Q	Custom map of 1024 unique values			
Frequency offset	Up to -60 MHz to +60 MHz			
Symbol rate	Internal generated data	1 sps to 75 Msps and max of 10 bits per symbol (Option 653 + 655)		
	External serial data	1 sps to [(50 Mbits/sec)/(#bits/symbol)]		
Filter types	Selectable	Nyquist, root-Nyquist, Gaussian, rectangular, APCO 25 (phase 1 and 2 UL and DL), IS-95, WCDMA, EDGE (wide and HSR)		
		IS-95 w/EQ, IS-95 Mod, IS-95 Mod w/EQ, HDQPSK, APCO25 HCPM, SOQPSK-TG		
	Custom FIR	16-bit resolution, up to 64 symbols long, automatically resampled to 1024 coefficients (max) > 32 to 64 symbol filter: symbol rate \leq 12.5 MHz > 16 to 32 symbol filter: symbol rate \leq 25 MHz Internal filters switch to 16 tap when symbol rate is between 25 and 75 MHz		
Quick setup modes	APCO 25 with (C4FM, CQPSK, HCPM, HDQPSK), TETRA , <i>Bluetooth</i> , CDPD, DECT, EDGE, GSM, NADC, PDC, PHS, PWT, WorldSpace, Iridium, ICO, CT2, TFTS			
	16APSK 2/3, 16APSK 3/4, 16APSK 4/5, 16APSK 5/6, 16APSK 8/9, 16APSK 9/10, 32APSK 3/4, 32APSK 4/5, 32APSK 5/6, 32APSK 8/9, 32APSK 9/10, SOQPSK			
Trigger delay	Range	0 to 1,048,575 bits		
	Resolution	1 bit		
Data types	Internally generated	Pseudo-random patterns	PN9, PN11, PN15, PN20, PN23	
		Repeating sequence	Any 4-bit sequence	
	Direct-pattern RAM [PRAM] max size Note: Used for custom TDMA/non-standard framing	32 Mb (standard)		
		512 Mb (Option 021)		
		1024 Mb (Option 022)		
	User file	32 MB (standard)		
		256 MB (Option 021)		
	512 MB (Option 022)			
Externally streamed data (via AUX I/O)	Type	Serial data		
	Inputs/outputs ¹	Data, symbol sync, bit clock		
Internal burst shape (varies with bit rate)	Rise/fall time range	Up to 30 bits		
	Rise/fall delay range	-15 to +15 bits		

1. Bit clock and symbol sync inputs will be available in future firmware release.

Multitone and two-tone (Option 430)		
Number of tones	2 to 512, with selectable on/off state per tone	
Frequency spacing	100 Hz to 120 MHz (with Option 653 and 655)	
Phase (per tone)	Fixed or random	
Real-time phase noise impairments (Option 432)		
Close-in phase noise characteristics	-20 dB per decade	
Far-out phase noise characteristics	-20 dB per decade	
Mid-frequency characteristics	Start frequency (f1)	Offset settable from 0 to 77 MHz
	Stop frequency (f2)	Offset settable from 0 to 77 MHz
Phase noise amplitude level (L(f))	User selected; max degradation dependent on f2	

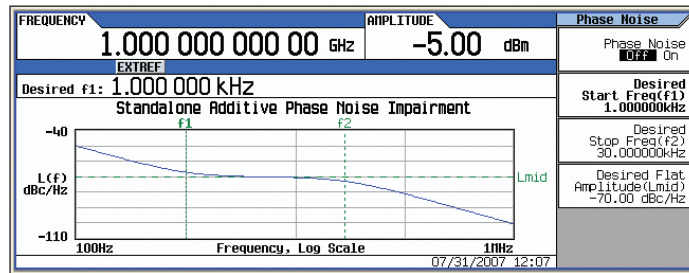

3GPP W-CDMA distortion performance ^{1,2}								
			Standard		Option UNV		Option UNV with Option 1EA	
Power level			≤ 2 dBm ²		≤ 2 dBm ²		≤ 5 dBm ²	
Offset	Configuration	Frequency	Spec	Typ	Spec	Typ	Spec	Typ
Adjacent (5 MHz)	1 DPCH, 1 carrier	1800 to 2200 MHz	-69 dBc	-73 dBc	-71 dBc	-75 dBc	-71 dBc	-75 dBc
Alternate (10 MHz)			-70 dBc	-75 dBc	-72 dBc	-77 dBc	-71 dBc	-77 dBc
Adjacent (5 MHz)	Test model 1 with 64 DPCH, 1 carrier	1800 to 2200 MHz	-68 dBc	-70 dBc	-71 dBc	-73 dBc	-71 dBc	-72 dBc
Alternate (10 MHz)				-73 dBc	-72 dBc	-76 dBc	-71 dBc	-76 dBc
Adjacent (5 MHz)	Test model 1 with 64 DPCH, 4 carrier	1800 to 2200 MHz	-63 dBc	-65 dBc	-65 dBc	-67 dBc	-64 dBc	-66 dBc
Alternate (10 MHz)				-64 dBc	-66 dBc	-66 dBc	-68 dBc	-66 dBc

1. ACPR specifications apply when the instrument is maintained within ± 20 to 30 °C.
2. This is rms power. Convert from rms to peak envelope power (PEP) with the following equation: PEP = rms power + crest factor (for example, 3GPP test model 1 with 64 DPCH has a crest factor 11.5 dB, therefore at +5 dBm rms, the PEP = 5 dBm + 11.5 dB = +16.5 dBm PEP).

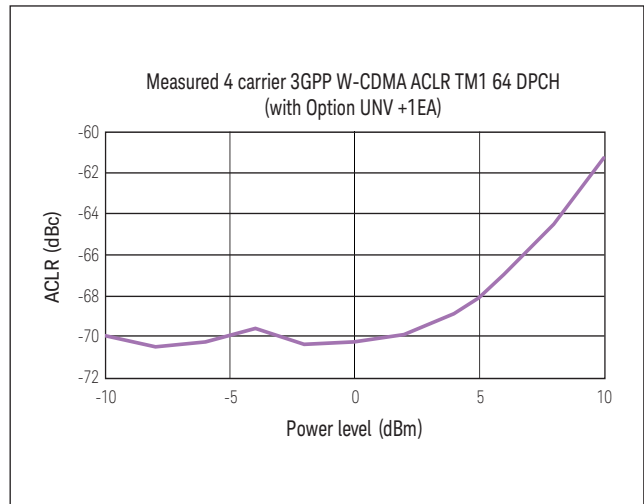
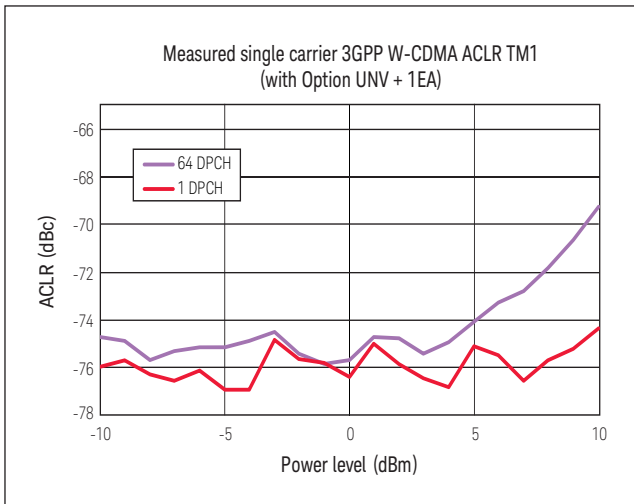

3GPP LTE-FDD distortion performance ¹			Standard		Option UNV		Option UNV with Option 1EA	
Power level			≤ 2 dBm ²		≤ 2 dBm ²		≤ 5 dBm ²	
Offset	Configuration	Frequency	Spec	Typ	Spec	Typ	Spec	Typ
Adjacent (10 MHz) ³	10 MHz E-TM 1.1	1800 to 2200 MHz	-64 dBc	-66 dBc	-67 dBc	-69 dBc	-64 dBc	-67 dBc
Alternate (20 MHz) ³	QPSK		-66 dBc	-68 dBc	-69 dBc	-71 dBc	-69 dBc	-71 dBc

- ACPR specifications apply when the instrument is maintained within ± 20 to 30 °C.
- This is rms power. Convert from rms to peak envelope power with the following equation: PEP = rms power + crest factor (for example, 3GPP test model 1 with 64 DPCH has a crest factor 11.5 dB, therefore at +5 dBm rms, the PEP = 5 dBm + 11.5 dB = +16.5 dBm PEP).
- ACPR measurement configuration: reference channel integration BW: 9.015 MHz, offset channel integration bandwidth: 9.015 MHz.

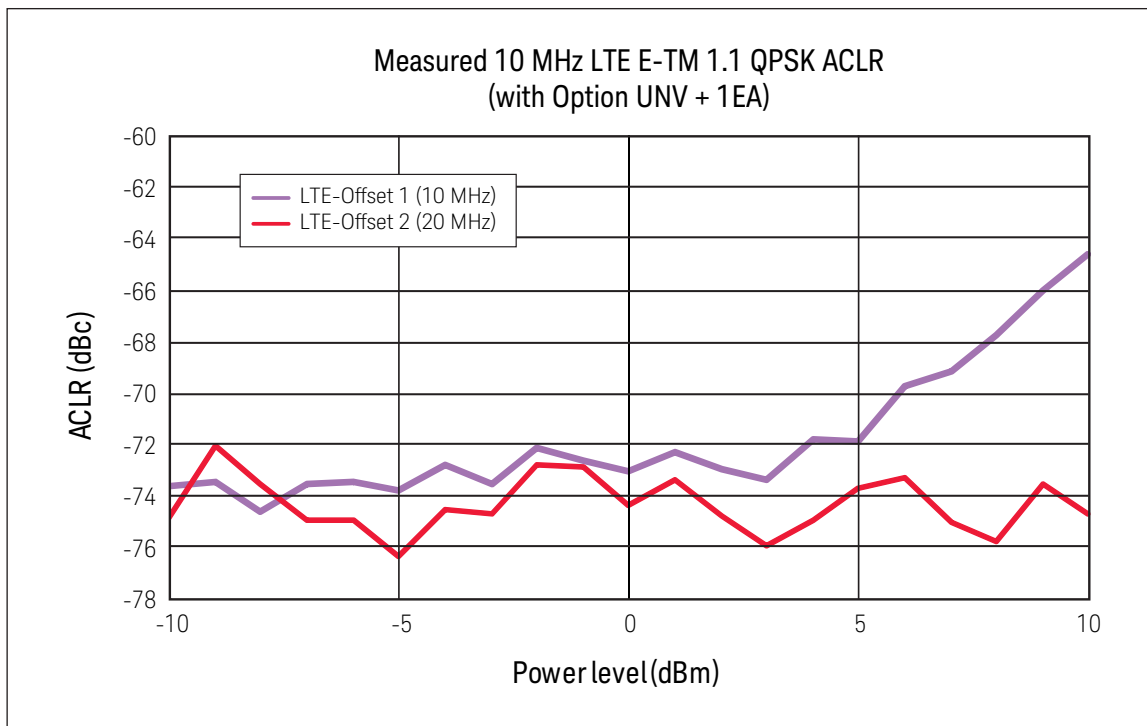

GSM/EDGE output RF spectrum (ORFS)						
			GSM		EDGE	
Power level			< +7 dBm		< +7 dBm	
Offset	Configuration	Frequency ¹	Standard, typical	Option UNV, typical	Standard, typical	Option UNV, typical
200 kHz	1 normal timeslot, burst	800 to 900 MHz 1800 to 1900 MHz	-34 dBc	-36 dBc	-37 dBc	-38 dBc
400 kHz			-69 dBc	-70 dBc	-69 dBc	-70 dBc
600 kHz			-81 dBc	-82 dBc	-80 dBc	-81 dBc
800 kHz			-82 dBc	-83 dBc	-82 dBc	-83 dBc
1200 kHz			-84 dBc	-85 dBc	-83 dBc	-84 dBc
3GPP2 cdma2000 distortion performance, typical						
			Standard	Option UNV	Option UNV + 1EA	
Power level ²			≤ 2 dBm	≤ 2 dBm	≤ 5 dBm	
Offset	Configuration	Frequency (1)	Typical	Typical	Typical	
885 kHz to 1.98 MHz	9 channel forward link	800 to 900 MHz	-78 dBc	-79 dBc	-77 dBc	
> 1.98 to 4.0 MHz			-86 dBc	-87 dBc	-87 dBc	
> 4.0 to 10 MHz			-91 dBc	-93 dBc	-93 dBc	
802.16e Mobile WiMAX™ distortion performance, measured						
Power	Offset ³	Configuration ⁴	Frequency	Standard, measured	UNV, measured	
< -7 dBm	10 MHz	QPSK	2.5 and 3.5 GHz	-65 dBc	-68 dBc	
Up to +5 dBm	10 MHz	QPSK	3.5 GHz	-62 dBc	-65 dBc	

1. Performance evaluated at bottom, middle, and top of bands shown.
2. This is rms power. Convert from rms to peak envelope power (PEP) with the following equation: $PEP = rms\ power + crest\ factor$ (for example: 3GPP test model 1 with 64 DPCH has a crest factor > 11 dB, therefore at +5 dBm rms the PEP = 5 dBm + 11 dB = +16 dBm PEP).
3. Measurement configuration: reference channel integration BW: 9.5 MHz, offset channel integration BW: 9 MHz, channel offset: 10 MHz.
4. 802.16e WiMAX signal configuration—bandwidth: 10 MHz, FFT: 1024, frame length: 5 ms, guard period: 1/8, symbol rolloff: 5%, content: 30 symbols of PN9 data.

EVM performance data ^{1,2}											
Format	GSM		EDGE		cdma2000/IS95A		W-CDMA		LTE FDD ³		
Modulation type	GMSK (burst)		3pi/8 8PSK (burst)		QPSK		QPSK		64 QAM		
Modulation rate	270.833 ksps		70.833 ksps		1.2288 Mcps		3.84 Mcps		10 MHz BW		
Channel configuration	1 timeslot		1 timeslot		Pilot channel		1 DPCH		E-TM 3.1		
Frequency ⁴	800 to 900 MHz 1800 to 1900 MHz		800 to 900 MHz 1800 to 1900 MHz		800 to 900 MHz 1800 to 1900 MHz		1800 to 2200 MHz		1800 to 2200 MHz		
EVM power level	≤ 7 dBm		≤ 7 dBm		≤ 7 dBm		≤ 7 dBm		≤ 7 dBm		
EVM power level with Option 1EA	≤ 13 dBm		≤ 13 dBm		≤ 13 dBm		≤ 13 dBm		≤ 13 dBm		
EVM/global phase error	Spec	Type	Spec	Type	Spec	Type	Spec	Type	Measured		
	ms 0.8 °	0.2 °	1.2%	0.75%	1.3%	0.8%	1.2%	0.8%	0.2%		
Format	802.11a/g		802.11ac ⁵		QPSK		16 QAM				
Modulation type	64 QAM		256 QAM		QPSK		16 QAM				
Modulation rate	54 Mbps		80 MHz BW		4 Msps (root-Nyquist filter $\alpha = 0.25$)						
Frequency ⁴	2400 to 2484 MHz		5.775 GHz		≤ 3 GHz		≤ 6 GHz		≤ 3 GHz		≤ 6 GHz
	5150 to 5825 MHz				≤ 4 dBm		≤ 4 dBm		≤ 4 dBm		≤ 4 dBm
EVM power level	≤ -5 dBm		≤ -5 dBm		≤ 4 dBm		≤ 4 dBm		≤ 4 dBm		≤ 4 dBm
EVM power level with Option 1EA	≤ 2 dBm		≤ 2 dBm		≤ 10 dBm		≤ 10 dBm		≤ 10 dBm		≤ 10 dBm
EVM	Measured	Measured	Spec	Type	Spec	Type	Spec	Type	Spec	Type	
	0.3%	0.4%	1.2%	0.8%	1.9%	1.1%	1.1%	0.65%	1.5%	0.9%	

1. EVM specifications apply for the default ARB file setup conditions with the default ARB files supplied with the instrument.
2. EVM specifications apply after execution of I/Q calibration when the instrument is maintained within ± 5 °C of the calibration temperature.
3. LTE FDD E-TM 3.1, 10 MHz, 64 QAM PDSCCH, full resource block. Measured EVM after DC calibration.
4. Performance evaluated at bottom, middle, and top of bands shown.
5. WLAN 802.11ac 80 MHz, 256 QAM, MCS 8, 7 symbols, no filtering. Channel corrections enabled. Rx equalizer training: preamble only.

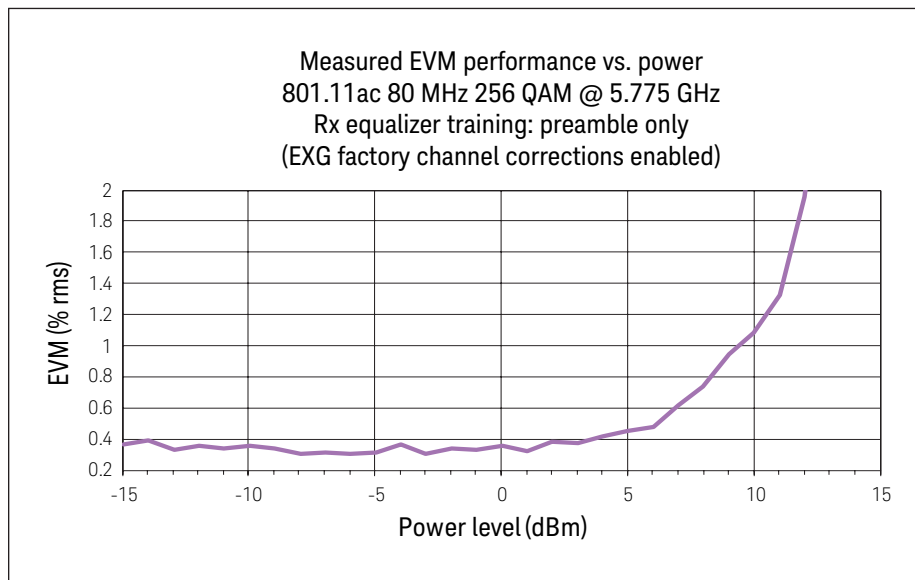

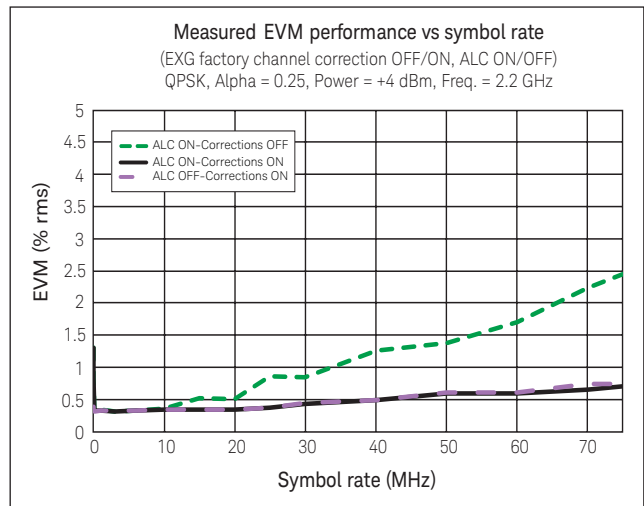
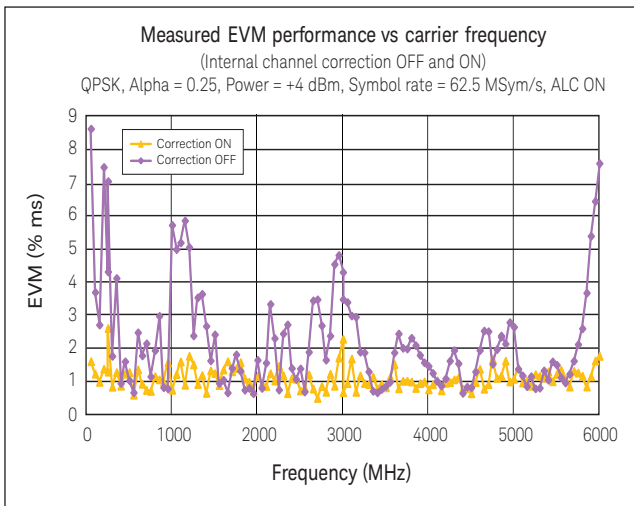
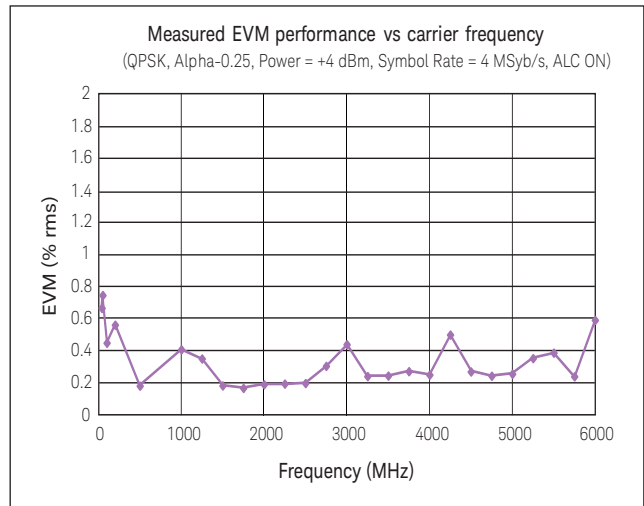
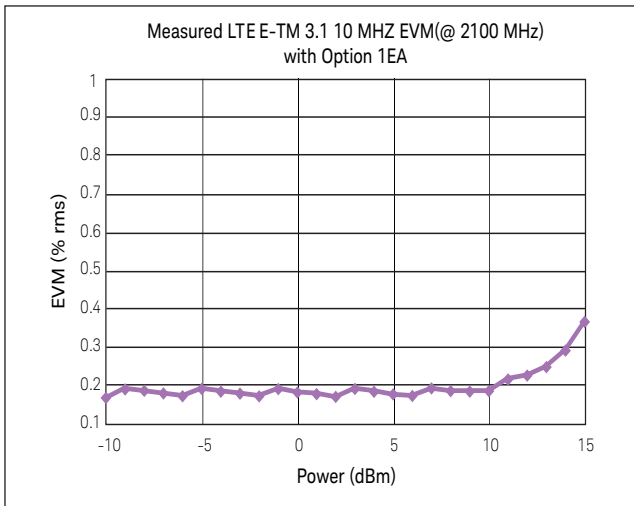

Bit error rate [BER] analyzer (Option UN7)	
Clock rate	100 Hz to 60 MHz (usable to 90 MHz)
Data patterns	PN9, 11, 15, 20, 23
Resolution	10 digits
Bit sequence length	100 bits to 4,294 Gbits after synchronization
Other features	Input clock phase adjustment and gate delay Direct measurement triggering Data and reference signal outputs Real-time display Bit count Error-bit-count Bit error rate Pass/fail indication Valid data and clock detection Automatic re-synchronization Special pattern ignore

General Specifications

Remote programming		
Interfaces	GPIB IEEE-488.2, 1987 with listen and talk LAN 1000BaseT LAN interface, LXI Class C compliant USB Version 2.0	
Control languages	SCPI Version 1997.0	
Compatibility languages	Keysight Technologies: N5181A\61A, N 5182A\62A, N5183A, E4438C, E4428C, E442xB, E443xB, E8241A, E8244A, E8251A, E8254A, E8247C, E8257C/D, E8267C/D, 8648 Series, 8656B, E8663B, 8657A/B, 8662A, 8663A	
	Aeroflex Inc.: 3410 Series	
	Rohde & Schwarz: SMB100A, SMBV100A, SMU200A, SMJ100A, SMATE200A, SMIQ, SML, SMV	
Power requirements		
100-120 VAC, 50/60/400 Hz		
220-240 VAC, 50/60 Hz		
160 W maximum (N5171B)		
300 W maximum (N5172B)		
Operating temperature range		
0 to 55 °C		
Storage temperature range		
-40 to 70 °C		
Operating and storage altitude		
Up to 15,000 feet		
Humidity		
Relative humidity - type tested at 95%, +40 °C (non-condensing)		
Environmental stress		
Samples of this product have been type tested in accordance with the Keysight Environmental Test Manual and verified to be robust against the environmental stresses of storage, transportation and end-use; those stresses include but are not limited to temperature, humidity, shock, vibration, altitude, and power line conditions; test methods are aligned with IEC 60068-2 and levels are similar to MIL-PRF-28800F Class 3		
Safety		
Complies with European Low Voltage Directive 2006/95/EC		
<ul style="list-style-type: none"> - IEC/EN 61010-1, 2nd Edition - Canada: CSA C22.2 No. 61010-1 - USA: UL std no. 61010-1, 2nd Edition - German Acoustic statement 	Acoustic noise emission LpA < 70 dB Operator position Normal position Per ISO 7779	Geräuschemission LpA < 70 dB Am Arbeitsplatz Normaler Betrieb Nach DIN 45635 t.19
EMC		
Complies with European EMC Directive 2004/108/EC		
<ul style="list-style-type: none"> - IEC/EN 61326-1 or IEC/EN 61326-2-1 - CISPR Pub 11 Group 1, class A - AS/NZS CISPR 11 - ICES/NMB-001 	This ISM device complies with Canadian ICES-001; cet appareil ISM est conforme a la norme NMB-001 du Canada	

Memory
<ul style="list-style-type: none"> – Memory is shared by instrument states, user data files, sweep list files, waveform sequences, and other files – 3 GB (30 GB with Option 009) memory available in the N5172B – Security Option 006 allows storage of up to 8 GB on SD card – Depending on how the memory is utilized, a maximum of 1000 instrument states can be saved
Security (Option 006)
<ul style="list-style-type: none"> – Removable 8 GB solid state memory (SD card) from rear panel – User can force all files to be stored only on external memory card including instrument states, user data files, sweep list files, waveforms, waveform sequences, and other files. – Memory sanitizing, memory sanitizing on, power on, and display blanking – Disable USB ports – Note: Read/write speeds to external memory card will be slower compared to internal solid-state drive (Option 009)
Self-test
Internal diagnostic routines test most modules in a preset condition; for each module, if its node voltages are within acceptable limits, the module passes the test
Weight
N5171B: ≤ 13.6 kg (30 lb) net, ≤ 28.6 kg (63 lb) shipping N5172B: ≤ 15.9 kg (35 lb) net, ≤ 30.8 kg (68 lb) shipping
Dimensions
88 mm H x 426 mm W x 489 mm L (length includes rear panel feet) (3.5 in H x 16.8 in W x 19.2 in L) Max length (L) including RF connector tip to end of rear panel feet is 508 mm (20 in)
Recommended calibration cycle
36 months
ISO compliant
This instrument is manufactured in an ISO-9001 registered facility in concurrence with Keysight Technologies' commitment to quality.

Inputs and Outputs

Front panel connectors	
RF output	Outputs the RF signal via a precision N type female connector; see output section for reverse power protection information
I and Q inputs	BNC input accepts "in-phase" and "quadrature" input signals for I/Q modulation; nominal input impedance is 50 Ω , damage levels are 1 V _{rms} and 5 V _{peak}
USB 2.0	Used with a memory stick for transferring instrument states, licenses and other files into or out of the instrument; also used with U2000, U848X, and U202X Series USB power sensors
Rear panel connectors	
Rear panel inputs and outputs are 3.3 V CMOS, unless indicated otherwise; CMOS inputs will accept 5 V CMOS, 3 V CMOS, or TTL voltage levels	
RF output (Option 1EM)	Outputs the RF signal via a precision N type female connector
I and Q inputs (Option 1EM)	Accepts "in-phase" and "quadrature" input signals for I/Q modulation SMB connector, nominal input impedance is 50 Ω ; damage levels are 1 V _{rms} and 5 V _{peak} ; Option 1EM units will come with 2 SMB to BNC adapters
I and Q outputs	BNC outputs the analog I/Q modulation signals from the internal baseband generator; nominal output impedance 50 Ω , DC coupled; damage levels ± 2 V
I bar and Q bar outputs (Option 1EL)	BNC outputs the complement of the I and Q signals for differential applications;

Event 1	<p>This connector outputs the programmable timing signal generated by marker 1</p> <p>The marker signal can also be routed internally to control the RF blanking and ALC hold functions; this signal is also available on the AUX I/O connector</p> <p>With bit error rate analyzer (Option UN7) this connector is used for data input</p> <p>Damage levels are $> +8\text{ V}$ and $< -4\text{ V}$</p>
Pattern trigger	<p>Accepts signal to trigger internal pattern generator to start single pattern output, for use with the internal baseband generators</p> <p>Accepts CMOS signal with minimum pulse width of 10 ns</p> <p>Female BNC</p> <p>Damage levels are $> +8\text{ V}$ and $< -4\text{ V}$</p>
BBTRIG 1	<p>For arbitrary and real-time baseband generators I/O such as Markers or trigger inputs</p> <p>With bit error rate analyzer (Option UN7) this connector is used for clock input</p>
BBTRIG 2	<p>For arbitrary and real-time baseband generators I/O such as Markers or trigger inputs</p> <p>With bit error rate analyzer (Option UN7) this connector is used for gate input</p>
Sweep out	<p>Generates output voltage, 0 to +10 V when the signal generator is sweeping; this output can also be programmed to indicate when the source is settled or output pulse video and is TTL and CMOS compatible in this mode; output impedance $< 1\ \Omega$, can drive 2 kΩ; damage levels are $\pm 15\text{ V}$</p>
Ext 1	<p>External AM/FM/PM #1 input; nominal input impedance is 50 Ω/600 Ω/1M Ω, nominal; damage levels are $\pm 5\text{ V}$</p>
Ext 2	<p>External AM/FM/PM #2 input; nominal input impedance is 50 Ω/600 Ω/1M Ω, nominal; damage levels are $\pm 5\text{ V}$</p>
LF OUT	<p>0 to 5 V peak into 50 Ω, -5 V to 5 V offset, nominal</p>
Pulse	<p>External pulse modulation input; this input is TTL and CMOS compatible; low logic levels are 0 V and high logic levels are +1 V; nominal input impedance is 50 Ω; input damage levels are $\leq -0.3\text{ V}$ and $\geq +5.3\text{ V}$</p>
Trigger in	<p>Accepts TTL and CMOS level signals for triggering point-to-point in sweep mode; damage levels are $\leq -0.3\text{ V}$ and $\geq +5.3\text{ V}$</p>
Trigger out	<p>Outputs a TTL and CMOS compatible level signal for use with sweep mode</p> <p>The signal is high at start of dwell, or when waiting for point trigger in manual sweep mode, and low when dwell is over or point trigger is received</p> <p>This output can also be programmed to indicate when the source is settled, pulse synchronization, or pulse video</p> <p>Nominal output impedance 50 Ω</p> <p>Input damage levels are $\leq -0.3\text{ V}$ and $\geq +5.3\text{ V}$</p>
Reference input	<p>Accepts a 10 MHz reference signal used to frequency lock the internal timebase; Option 1ER adds the capability to lock to a frequency from 1 MHz to 50 MHz; nominal input level -3 to +20 dBm, impedance 50 Ω, sine or square waveform</p>
10 MHz out	<p>Outputs the 10 MHz reference signal used by internal timebase; level nominally +3.9 dBm; nominal output impedance 50 Ω; input damage level is +16 dBm</p>
LO in (Option 012)	<p>Accepts a signal from a master signal generator that is used as the LO for EXG vector in order to configure a phase coherent system; nominal input levels between 0 to +12 dBm; nominal input impedance 50 Ω</p>
LO out (Option 012)	<p>Outputs a reference signal that can be used in a phase coherent system; nominal output levels between 0 to +12 dBm; nominal output impedance 50 Ω</p>
DAC Clk In (Option 012)	<p>Reserved for future use.</p>
Digital bus I/O	<p>To be used with PXB or N5102A digital signal interface module</p>

Aux I/O	<p>Aux I/O port sends and/or receives auxiliary signaling information: For Option UN7 this connector is used to output reference data, clock, error signals, and more Output markers to an external device from arbitrary waveform or real-time generation application such as: frame markers, pulse-per-second, even-second, and more. Input signals from external DUT to modify characteristics of a signal being generated. Such as: changing output power (power control loop testing), advancing or delaying timing (timing advance loop testing), HARQ ACK/NAK delivery (HARQ process loop testing) or streaming external data, clock and symbol synch for custom modulation. I/O is application specific (CDMA, 3GPP, GNSS, LTE, custom etc). See User Guide or Signal Studio help for more details. Connector type: 36 pin 3M connector (part number N10236-52B2PC). The mating connector is a 3M 10136-3000 wire mount plug or 3M 10136-8000 IDC plug with a 3M 10336 shell.</p> <p>For Option 431 real-time custom modulation the follow pin numbers are assigned: Data input = pin 23 Data clock input = pin 29 Symbol sync input = pin 25 Burst input = pin 27 Data output = pin 35 Data clock output = pin 6 Symbol sync output = pin 37 Event 1 output = pin 1 Event 2 output = pin 33</p>
USB 2.0	The USB connector provides remote programming functions via SCPI
LAN (1000 BaseT)	<p>The LAN connector provides the same SCPI remote programming functionality as the GPIB connector and is also used to access the internal Web server and FTP server Supports DHCP, sockets SCPI, VXI-11 SCPI, connection monitoring, dynamic hostname services, TCP keep alive LXI class C compliant Trigger response time for the immediate LAN trigger is 0.5 ms (minimum), 4 ms (maximum), 2 ms, typical; delayed/ alarm trigger is unknown Trigger output response time is 0.5 ms (minimum), 4 ms (maximum), 2 ms, typical</p>
GPIB	The GPIB connector provides remote programming functionality via SCPI

Related Literature

Keysight X-Series Signal Generators

<i>EXG Configuration Guide</i>	5990-9958EN
<i>MXG Data Sheet</i>	5991-0038EN
<i>MXG Configuration Guide</i>	5990-9959EN
<i>X-Series Signal Generator Brochure</i>	5990-9957EN
<i>Signal Studio Software Brochure</i>	5989-6448EN

Evolving

Our unique combination of hardware, software, support, and people can help you reach your next breakthrough. **We are unlocking the future of technology.**

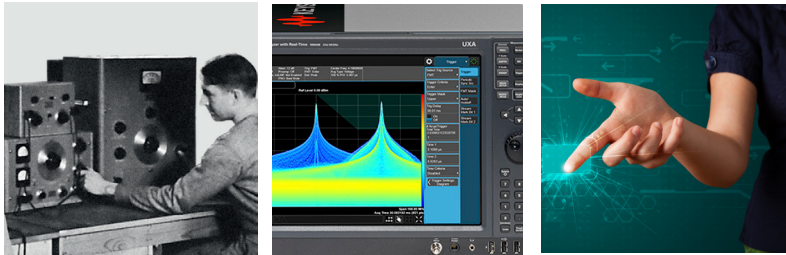

From Hewlett-Packard to Agilent to Keysight



myKeysight
myKeysight

myKeysight
www.keysight.com/find/mykeysight
A personalized view into the information most relevant to you.

Keysight Infoline

Keysight Infoline
www.keysight.com/find/Infoline
Keysight's insight to best in class information management. Free access to your Keysight equipment company reports and e-library.

KEYSIGHT SERVICES

Keysight Services
www.keysight.com/find/services
Our deep offering in design, test, and measurement services deploys an industry-leading array of people, processes, and tools. The result? We help you implement new technologies and engineer improved processes that lower costs.



Three-Year Warranty
www.keysight.com/find/ThreeYearWarranty
Keysight's committed to superior product quality and lower total cost of ownership. Keysight is the only test and measurement company with three-year warranty standard on all instruments, worldwide. And, we provide a one-year warranty on many accessories, calibration devices, systems and custom products.



Keysight Assurance Plans
www.keysight.com/find/AssurancePlans
Up to ten years of protection and no budgetary surprises to ensure your instruments are operating to specification, so you can rely on accurate measurements.

Keysight Channel Partners
www.keysight.com/find/channelpartners
Get the best of both worlds: Keysight's measurement expertise and product breadth, combined with channel partner convenience.

cdma2000 is a US registered certification mark of the Telecommunications Industry Association.
Bluetooth and the Bluetooth logos are trademarks owned by Bluetooth SIG, Inc, U.S.A. and licensed to Keysight Technologies, Inc.
WiMAX is a US trademark of the WiMAX Forum.
www.keysight.com/find/exg

For more information on Keysight Technologies' products, applications or services, please contact your local Keysight office. The complete list is available at: www.keysight.com/find/contactus

Americas
Canada (877) 894 4414
Brazil 55 11 3351 7010
Mexico 001 800 254 2440
United States (800) 829 4444

Asia Pacific
Australia 1 800 629 485
China 800 810 0189
Hong Kong 800 938 693
India 1 800 11 2626
Japan 0120 (421) 345
Korea 080 769 0800
Malaysia 1 800 888 848
Singapore 1 800 375 8100
Taiwan 0800 047 866
Other AP Countries (65) 6375 8100

Europe & Middle East
Austria 0800 001122
Belgium 0800 58580
Finland 0800 523252
France 0805 980333
Germany 0800 6270999
Ireland 1800 832700
Israel 1 809 343051
Italy 800 599100
Luxembourg +32 800 58580
Netherlands 0800 0233200
Russia 8800 5009286
Spain 800 000154
Sweden 0200 882255
Switzerland 0800 805353
Opt. 1 (DE)
Opt. 2 (FR)
Opt. 3 (IT)
United Kingdom 0800 0260637

For other unlisted countries:
www.keysight.com/find/contactus
(BP-06-08-16)



www.keysight.com/go/quality
Keysight Technologies, Inc.
DEKRA Certified ISO 9001:2015
Quality Management System